

Winstel Controls-Morrow Control

2023 Spring Equipment Catalog

Table of Content

Comfortaire	3
Air Conditioners	3
Inverter Heat Pumps	4
Coils	5
Air Handlers	7
Gas Furnaces	8
Room Air	10
Aireforce	11
AC/Heat Pumps	11
Coils	12
Furnaces	13
Air Handlers/Heat Strip	14
Bosch	15
Inverter Ducted Split	15
Inverter Ducted Packaged	17
Ductless Minisplit Systems	18
Gree	20
Ductless Minisplit Systems	20
Ductless Minisplit Accessories	21
Thermopride	23
Oil Furnace	23
Modine	24
Unit Heaters	24
Enerco	25
Radiant Heater	25
Accessory Items	26
Supplies	28
IAQ	32
Sheet Metal	34

13 Seer R410A Air Conditioners

12 year parts Warranty when registered ***To be replaced by HCRSG14 (2023)

Item ID	TONS	DIMENSIONS	LINESET	Price
HCRSG1318S1M	1.5	24.25 x 24.25 x 25	3/8 - 5/8	
HCRSG1324S1M	2.0	24.25 x 24.25 x 25	3/8 - 5/8	
HCRSG1330S1M	2.5	24.5 x 24.5 x 29	3/8 - 3/4	
HCRSG1336S1M	3.0	24.5 x 24.5 x 29	3/8 - 3/4	
HCRSG1342S1M	3.5	28.25 x 28.25 x 29	3/8 - 3/4	
HCRSG1348S1M	4.0	28.25 x 28.25 x 33	3/8 - 7/8	
HCRSG1360S1M	5.0	28.25 x 28.25 x 29	3/8 - 7/8	



14 Seer R410A Air Conditioners

12 Year parts Warranty when Registered

Item ID	TONS	DIMENSIONS	LINESET	Price
HCRSG1418S1P	1.5	24.25 X 24.25 X 29	3/8 - 3/4	
HCRSG1424S1P	2.0	28.25 X 28.25 X 29	3/8 - 3/4	
HCRSG1430S1P	2.5	28.25 X 28.25 X 37	3/8 - 3/4	
HCRSG1436S1P	3.0	28.25 X 28.25 X 29	3/8 - 7/8	
HCRSG1442S1P	3.5	28.25 X 28.25 X 37	3/8 - 7/8	
HCRSG1448S1P	4.0	28.25 X 28.25 X 37	3/8 - 7/8	
HCRSG1460S1P	5.0	32.25 X 32.25 X 43	3/8 - 1-1/8	



16 Seer R410A Air Conditioners

12 Year parts Warranty when Registered

Item ID	TONS	DIMENSIONS	LINESET	Price
HCRSG1618S1P	1.5	24.25 x 24.25 x 29	3/8 - 3/4	
HCRSG1624S1P	2.0	28.25 x 28.25 x 39	3/8 - 3/4	
HCRSG1630S1P	2.5	28.25 x 28.25 x 37	3/8 - 3/4	
HCRSG1636S1P	3.0	28.25 x 28.25 x 29	3/8 - 7/8	
HCRSG1641S1P	3.5	28.25 x 28.25 x 37	3/8 - 7/8	
HCRSG1647S1P	4.0	32.25 x 32.25 x 43	3/8 - 7/8	



18 Seer Inverter R410A Heat Pumps

12 Year parts Warranty when Registered

Item ID	TONS	DIMENSIONS	LINESET	Price
HCHRG1836S1P	1.5	28.25 X 28.25 X 43.25	3/8 - 3/4	
HCHRG1860S1P	2.0	28.25 X 28.25 X 43.25	3/8 - 3/4	



See Bosch Section for Inverter Heat Pumps

For Multiple Inverter options go the section on Bosch Inverter Heat Pumps to see our full product offering.

Price

410A Cased Coils with Piston

Item ID	TONS	DIM W X D X H	ORIFICE	Price
HCMCG1824PA1P	1.5 to 2	14.5 x 21 x 16.5	.053	
HCMCG1824PB1P	1.5 to 2	17.5 X 21 X 16.5	.053	
HCMCG30PA2P	2.5	14.5 X 21 X 20.5	.059	
HCMCG30PB2P	2.5	17.5 X 21 X 20.5	.059	
HCMCG30PC2P	2.5	21 X 21 X 20.5	.059	
HCMCG36PB7P	3.0	17.5 X 21 X 20.5	.067	
HCMCG36PC7P	3.0	21 X 21 X 20.5	.067	
HCMCG42PC6P	3.5	21 X 21 X 24.5	.073	
HCMCG48PC9P	4.0	21 X 21 X 27.5	.076	
HCMCG48PD9P	4.0	24.4 X 21 X 27.5	.076	
HCMCG60PCBP	5.0	21 X 21 X 31.5	.093	
HCMCG60PDAP	5.0	24.5 X 21 X 27.5	.093	



410A Uncased Coils with Piston

Item ID	TONS	DIM W X D X H	ORIFICE	Price
HCCCG1824PA1P	1.5 to 2	14 X 19.5 X 13	.053	
HCCCG1824PB1P	1.5 to 2	17 X 19.5 X 13	.053	
HCCCG30PA2P	2.5	14 X 19.5 X 17	.059	
HCCCG30PB2P	2.5	17 X 19.5 X 17	.059	
HCCCG36PA7P	3.0	14 X 19.5 X 19	.067	
HCCCG36PB7P	3.0	17 X 19.5 X 19	.067	
HCCCG36PC7P	3.0	20 X 19.5 X 19	.067	
HCCCG42PB6P	3.5	17 X 19.5 X 19	.067	
HCCCG42PC6P	3.5	20 X 19.5 X 19	.073	
HCCCG48PC9P	4.0	20 X 19.5 X 25	.076	
HCCCG60PCAP	5.0	20 X 19.5 X 27	.093	
HCCCG60P23E	5.0		.093	

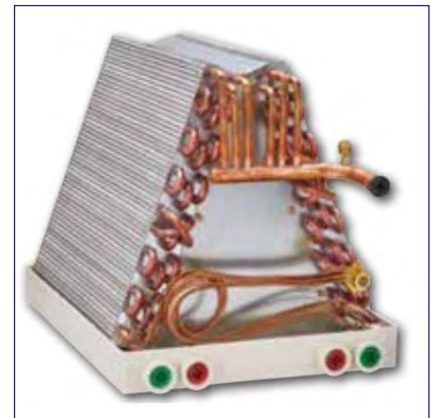

410A Cased Coils with TXV Installed

Item ID	TONS	DIM W X H X D	LINESET	Price
HCMCG1824TA1P	1.5 to 2	14.5 X 16.5 X 21	3/8 - 3/4	
HCMCG1824TB1P	1.5 to 2	17.5 X 16.5 X 21	3/8 - 3/4	
HCMCG1824TC1P	1.5 to 2	21 X 16.5 X 21	3/8 - 3/4	
HCMCG3036TA4P	2.5 to 3	14.5 X 16.5 X 21	3/8 - 3/4	
HCMCG3036TB4P	2.5 to 3	17.5 X 16.5 X 21	3/8 - 3/4	
HCMCG3036TC4P	2.5 to 3	21 X 16.5 X 21	3/8 - 3/4	
HCMCG4248TC8P	3.5 to 4	21 X 25.5 X 21	3/8 - 7/8	
HCMCG4248TD8P	3.5 to 4	24.5 X 25.5 X 21	3/8 - 7/8	
HCMCG60TCAP	5.0	21 X 27.5 X 21	3/8 - 7/8	
HCMCG60TDAP	5.0	24.5 X 27.5 X 21	3/8 - 7/8	



Uncased Aftermarket Aspen Coils

Item ID	TONS	DIM W X H X D	LINESET	Price
ASPCA24A3G-130R-003	2.0	13 X 13.5 X 19.4	3/8 - 3/4	
ASPCA30A3G-130R-003	2.5	13 X 15.5 X 19.4	3/8 - 3/4	
ASPCA30A3G-160R-003	2.5	16 X 15.5 X 19.4	3/8 - 3/4	
ASPCA36A3G-160R-003	3.0	16 X 17.5 X 19.4	3/8 - 3/4	
ASPCA36A3G-195R-003	3.0	19.5 X 17.5 X 19.4	3/8 - 3/4	
ASPCA48A3G-195R-003	4.0	19.5 X 21.5 X 19.4	3/8 - 7/8	
ASPCA60A3G-195R-003	5.0	19.5 X 25.5 X 19.4	3/8 - 7/8	
ASPCM36A3G-177L-006	1.5 to 3		Mobile Home Coil	

ECM Variable Speed HCG Series with TXV

12 Year parts Warranty when Registered

Item ID	TONS	DIM W X H X D	LINESET	Price
HCHCG24V1P	2.0	18.5 X 45.5 X 22	3/8 - 3/4	
HCHCG30V1P	2.5	18.5 X 47 X 22	3/8 - 3/4	
HCHCG36V1P	3.0	21.5 X 53.5 X 22	3/8 - 3/4	
HCHCG42V1P	3.5	21.5 X 53.5 X 22	3/8 - 7/8	
HCHCG48V1P	4.0	21.5 X 55 X 22	3/8 - 7/8	
HCHCG60V1P	5.0	21.5 X 59.75 X 22	3/8 - 7/8	



Heat Kits

Item ID	KW	CIRCUIT BREAKER	Price
HC16Y39	5.0	Yes	
HC16Y41	7.5	Yes	
HC16Y42	10.0	Yes	
HC16Y43	12.5	Yes	
HC16Y44	15.0	Yes	
HC16Y46	20.0	Yes	

Non-Stock For Boiler Loops AHG Series

12 Year parts Warranty when Registered

Item ID	TONS	Price
HCAHG24-0A	2.0	
HCAHG30-0A	2.5	
HCAHG36-0A	3.0	
HCAHG48-0A	4.0	
HCAHG60-0A	5.0	



Non-Stock TXV for AHG Series

12 Year parts Warranty when Registered

Item ID	DESCRIPTION	REFRIGERANT	Price
HC7606-201	TXV For 1.5 to 3	R410	
HC7606-202	TXV for 3.5 to 5	R410	

80% Upflow/Horizontal ECM Constant

12 Year parts Warranty when Registered

Item ID	BTUS	DIM W X H X D	Price
HCGUH80C045A3M	45,000	14.5 X 33 X 28.5	
HCGUH80C070A3M	70,000	14.5 X 33 X 28.5	
HCGUH80C070B3M	70,000	17.5 X 33 X 28.5	
HCGUH80C090B4M	90,000	17.5 X 33 X 28.5	
HCGUH80C090C5M	90,000	21 X 33 X 28.5	
HCGUH80C110C5M	110,000	21 X 33 X 28.5	
HCGUH80C135D5M	135,000	24.5 X 33 X 28.5	



80% Downflow Only ECM Constant

12 Year parts Warranty when Registered

Item ID	BTUS	DIM W X H X D	Price
HCGDD80C045A3M	45,000	14.5 X 33 X 28.5	
HCGDD80C070B3M	70,000	17.5 X 33 X 28.5	
HCGDD80C090B4M	90,000	17.5 X 33 X 28.5	
HCGDD80C110C5M	110,000	21 X 33 X 28.5	



92% Upflow/Horizontal 1 Stage ECM Constant

12 Year parts Warranty when Registered

Item ID	BTUS	DIM W X H X D	Price
HCGUH92C045B3M	45,000	17.5 X 33 X 28.5	
HCGUH92C070B3M	70,000	17.5 X 33 X 28.5	
HCGUH92C090C3M	90,000	21 X 33 X 28.5	
HCGUH92C090C4M	90,000	21 X 33 X 28.5	
HCGUH92C110C4M	110,000	21 X 33 X 28.5	
HCGUH92C110C5M	110,000	21 X 33 X 28.5	



95% Upflow/Horizontal ECM Constant

12 Year parts Warranty when Registered

Item ID	BTUS	DIM W X H X D	Price
HCGUH95C045B3M	45,000	17.5 X 33 X 28.5	
HCGUH95C070B3M	70,000	17.5 X 33 X 28.5	
HCGUH95C090C4M	90,000	21 X 33 X 28.5	
HCGUH95C110C5M	110,000	21 X 33 X 28.5	
HCGUH95C135D5M	135,000	24.5 X 33 X 28.5	



95% Downflow Only ECM Constant

12 Year parts Warranty when Registered

Item ID	BTUS	DIM W X H X D	Price
HCGDD95C045B3M	45,000	17.5 X 33 X 28.5	
HCGDD95C070B4M	70,000	17.5 X 33 X 28.5	
HCGDD95C090C4M	90,000	21 X 33 X 28.5	
HCGDD95C110C5M	110,000	21 X 33 X 28.5	



96% Upflow/Horizontal ECM Constant

12 Year parts Warranty when Registered

Item ID	BTUS	DIM W X H X D	Price
HCGUH96C045B3M	45,000	17.5 X 33 X 28.5	
HCGUH96C070B3M	70,000	17.5 X 33 X 28.5	
HCGUH96C090C4M	90,000	17.5 X 33 X 28.5	
HCGUH96C110C5M	110,000	17.5 X 33 X 28.5	
HCGUH96C135D5M	135,000	17.5 X 33 X 28.5	



96% 2-Stage 96% Upflow ECM-Variable

12 Year parts Warranty when Registered

Item ID	BTUS	DIM W X H X D	Price
HCGUH96T045B3M	45,000	17.5 X 33 X 28.5	
HCGUH96T070B3M	70,000	17.5 X 33 X 28.5	
HCGUH96T090C3M	90,000	21 X 33 X 28.5	
HCGUH96T090C5M	90,000	21 X 33 X 28.5	
HCGUH96T110C5M	110,000	21 X 33 X 28.5	
HCGUH96T135D5M	135,000	24.5 X 33 X 28.5	



Accessories

Item ID	DESCRIPTION	Price
HC11K48	LP Kit - All 2 Stage Furnaces	
HC11K50	LP Kit - All Single Stage Furnaces	
HC51W11	Flush Mount Termination Kit 2" and 3"	
HC68W80	Night Service Kit - All A Model Furnaces	
HC84W50	Night Service Kit - All 95T, 96T Gas Furnaces	

Window AC/Room Air

Item ID	BTUS	TYPE	VOLTAGE	Price
HCRADS-81Q	8,000	Cooling Only	115V	
HCRADS-101Q	10,100	Cooling Only	115V	
HCRADS-121Q	12,100	Cooling Only	115V	
HCRADS-151Q	15,100	Cooling Only	115V	
HCAS080		Bracket		



Window HP/Room Air

Item ID	BTUS	TYPE	VOLTAGE	Price
HCREG-81M	8,000	Heat/Cool	115V	
HCREG-123M	12,000	Heat/Cool	208-230V	
HCREG-183M	18,500	Heat/Cool	208-230V	
HCREG-253M	25,000	Heat/Cool	208-230V	
HCAS080				



13 Seer R410A Air Conditioner

10 Year parts Warranty when Registered

Item ID	MODEL	TONNAGE	Price
AIR1021685W	WSA2BD4M1SN18K	1.5	
AIR1021686W	WSA2BD4M1SN24KA	2.0	
AIR1021687W	WSA2BD4M1SN30K	2.5	
AIR1021688W	WSA2BD4M1SN36K	3.0	
AIR1021689W	WSA2BD4M1SN42K	3.5	
AIR1021690W	WSA2BD4M1SN48K	4.0	
AIR1021691W	WSA2BD4M1SN60K	5.0	



14 Seer R410A Heat Pump

10 Year parts Warranty when Registered

Item ID	MODEL	TONNAGE	Price
AIR1021737W	WSH2BE4M1SP24K	2.0	
AIR1021738W	WSH2BE4M1SP30K	2.5	
AIR1021739W	WSH2BE4M1SP36K	3.0	
AIR1021740W	WSH2BE4M1SP48K	4.0	
AIR1021741W	WSH2BE4M1SP60K	5.0	



Uncased Coils with Piston

Item ID	MODEL	TONNAGE	Price
AIR921514	C7BAM01824U-A	1.5-2.0	
AIR921518	C7BAM01824U-B	1.5-2.0	
AIR921520	C7BAM03036U-B	2.5-3.0	
AIR921699	C7BAM030U-C	3.0	
AIR921522	C7BAM03642U-B	3.0-3.5	
AIR921524	C7BAM03648U-C	3.0-4.0	
AIR921840	C7BAM048U-D	4.0	
AIR922115	C7BAM060U-C	5.0	
AIR922118	C7BAM060U-D	5.0	

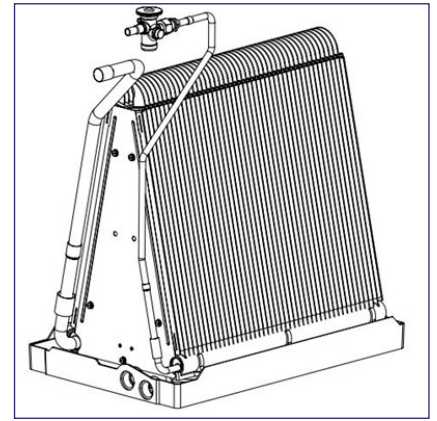

Case Coils with Piston

Item ID	MODEL	TONNAGE	Price
AIR921519	C7BAM01824C-BP	1.5-2.0	
AIR921521	C7BAM03036C-BP	2.5-3.0	
AIR921700	C7BAM030C-CP	2.5	
AIR921523	C7BAM03642C-BP	3.0-3.5	
AIR921525	C7BAM03648C-CP	3.0-4.0	
AIR921841	C7BAM048C-DP	4.0	
AIR922116	C7BAM060C-CP	5.0	
AIR922119	C7BAM060C-DP	5.0	



80% Upflow/Horizontal 1 Stage

10 Year parts Warranty when Registered

Item ID	MODEL	BTU'S	EFFICIENCY	Price
AIR1025482K	KG7SA-045C-T23AP	45,000	80%	
AIR1025483K	KG7SA-054C-T23AP	54,000	80%	
AIR1025481K	KG7SA-072C-T24BP	72,000	80%	
AIR1025485K	KG7SA-072C-T35CP	72,000	80%	
AIR1025484K	KG7SA-090C-T24BP	90,000	80%	
AIR1025486KP	KG7SA-090C-T35CP	90,000	80%	
AIR1025487K	KG7SA-108C-T35CP	108,000	80%	
AIR1025488K	KG7SA-126C-T45DP	126,000	80%	



92/95% Upflow/Horizontal 1 Stage

10 Year parts Warranty when Registered

Item ID	MODEL	BTU'S	EFFICIENCY	Price
AIR1025502K	KG7SD054DT24B1	54,000	95%	
AIR1025496K	KG7SC072DT24BP	72,000	92%	
AIR1025503K	KG7SD072DT35C1	72,000	95%	
AIR1025504K	KG7SD090DT35C1	90,000	95%	
AIR1025505K	KG7SD108DT45	108,000	95%	



Air Handler Multiposition

10 Year parts Warranty when Registered. Can be used in horizontal, upflow, downflow and vertical applications

Item ID	TONS	WIDTH	Price
AIR921146	2.0	19-3/4	
AIR921148	2.5	19-3/4	
AIR921150	3.0	19-3/4	
AIR921151	3.5	19-3/4	
AIR921153	4.0	22-1/2	
AIR921154	5.0	22-1/2	



Heater Kits

Item ID	AMPS	CIRCUIT BREAKER	VOLTAGE	Price
NRD922521	5	Yes	240/1	
NRD922523	8	Yes	240/1	
NRD922526	10	Yes	240/1	
NRD922527	15	Yes	240/1	
NRD922529	20	Yes	240/1	
NRD922530	25	Yes	240/1	
NRD922532	30	Yes	240/1	

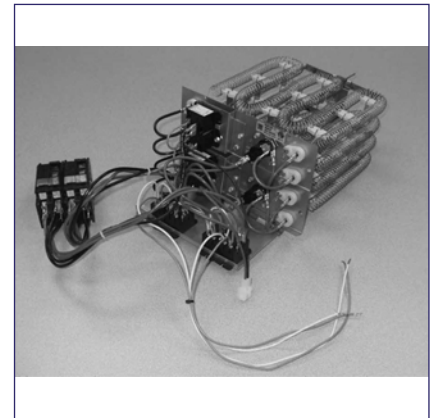

IDS Light Condenser

10 Year parts Warranty

Item ID	TONS	SEER	Price
BOSBOVA24HDN1M15G	1-2	15	
BOSBOVA36HDN1M15G	3	15	
BOSBOVA60HDN1M15G	4-5	15	



IDS Plus Condenser

10 Year parts Warranty

Item ID	TONS	SEER	Price
BOSBOVB36HDN1M18M	1-3	18	
BOSBOVB60HDN1M18M	4-5	18	



IDS Premium Condenser

10 Year parts Warranty

Item ID	TONS	SEER	CONNECTED	Price
BOSBOVA36HDN1M20G	1-3	20	No	
BOSBOVA60HDN1M20G	4-5	20	No	
BOSBOVB36HDN1M20G	1-3	20	Yes	
BOSBOVB60HDN1M20G	4-5	20	Yes	



IDS Light Air Handler

10 Year parts Warranty

Item ID	TONS	MATCH WITH	Price
BOSBVA24WN1M15	2	Light/Plus	
BOSBVA36WN1M15	3	Light/Plus	
BOSBVA48WN1M15	4	Light/Plus	
BOSBVA60WN1M15	5	Light/Plus	



IDS Plus/Premium Air Handlers

10 Year parts Warranty

Item ID	TONS	MATCH WITH	Price
BOSBVA24WN1M20	2	Light/Plus/Premium	
BOSBVA36WN1M20	3	Light/Plus/Premium	
BOSBVA48WN1M20	4	Light/Plus/Premium	
BOSBVA60WN1M20	5	Light/Plus/Premium	



IDS Light/Plus/Premium Heater Kits

10 Year parts Warranty

Item ID	KW	MATCH WITH	Price
BOSWEHK05B	5	Light/Plus/Premium	
BOSWEHK08B	8	Light/Plus/Premium	
BOSWEHK10B	10	Light/Plus/Premium	
BOSWEHK15B	15	Light/Plus/Premium	
BOSWEHK20B	20	Light/Plus/Premium	

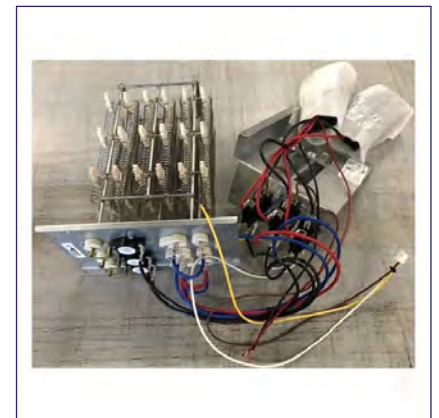

IDS Light/Plus/Premium Coils

10 Year parts Warranty

Item ID	TONS	DIMENSIONS	MATCH WITH	Price
BOSBMAC2430ANTD	2	14.5	All IDS	
BOSBMAC2430BNTD	2	17.5	All IDS	
BOSBMAC3036ANTD	3	14.5	All IDS	
BOSBMAC3036BNTD	3	17.5	All IDS	
BOSBMAC3036CNTD	3	21	All IDS	
BOSBMAC4248BNTF	4	17.5	All IDS	
BOSBMAC4248CNTF	4	21	All IDS	
BOSBMAC4248DNTF	4	24.5	All IDS	
BOSBMAC4860CNTF	5	21	All IDS	
BOSBMAC4860DNTF	5	24.5	All IDS	



IDS Light/Plus/Premium Furnaces

10 Year parts Warranty

Item ID	BTUS	DIMENSIONS	MATCH WITH	Price
BOSBGH96M060B3A	60000	17.5	All IDS	
BOSBGH96M080B3A	80000	17.5	All IDS	
BOSBGH96M080C4A	80000	21	All IDS	
BOSBGH96M100C5A	100000	21	All IDS	
BOSBGH96M100D5A	100000	24	All IDS	
BOSBGH96M120D5B	120000	24	All IDS	



Packaged Units

Item ID	TONS	Price
BOSBRB-60HWD1N1-M19	5	
BOSBRB36HWD1N1M18	3	



Packaged Unit Heat Kits

Item ID	KW	Price
BOSEHK-05J	5	
BOSEHK-08J	8	
BOSEHK-10J	10	
BOSEHK-15J	15	
BOSEHK-20J	20	

115V Systems

Item ID	CAPACITY (BTUS)	VOLTAGE	Price
BOSBMS500-AAS012-0AHWXB	12000	115	
BOSBMS500-AAS012-0CSXRB	12000	115	Wall Mount Only



Condenser

Item ID	CAPACITY (BTUS)	ZONES	MATCH WITH	Price
BOSBMS500-AAS009-1CSXRA	9000	Single	Universal	
BOSBMS500-AAS012-1CSXRA	12000	Single	Universal	
BOSBMS500-AAS018-1CSXRA	18000	Single	Universal	
BOSBMS500-AAS024-1CSXRA	24000	Single	Universal	
BOSBMS500-AAM018-1CSXRA	18000	Multi	Universal	
BOSBMS500-AAM027-1CSXRA	27000	Multi	Universal	
BOSBMS500-AAM036-1CSXRA	36000	Multi	Universal	
BOSBMS500-AAM048-1CSXRA	48000	Multi	Universal	
BOSBMS500-AAS030-1CSXRB	30000	Single	Wall Mount Only	
BOSBMS500-AAS036-1CSXRB	36000	Single	Wall Mount Only	



Condenser Max Performance

Item ID	CAPACITY (BTUS)	ZONES	MATCH WITH	Price
BOSBMS500-AAS009-1CSXHB	9000	Single	Universal	
BOSBMS500-AAS012-1CSXHB	12000	Single	Universal	
BOSBMS500-AAS018-1CSXHB	18000	Single	Universal	
BOSBMS500-AAS024-1CSXHB	24000	Single	Universal	
BOSBMS500-AAM018-1CSXHB	18000	Multi	Universal	
BOSBMS500-AAM027-1CSXHB	27000	Multi	Universal	
BOSBMS500-AAM036-1CSXHB	36000	Multi	Universal	

Condenser Light Commercial

Item ID	CAPACITY (BTUS)	ZONES	MATCH WITH	Price
BOSBMS500-AAS036-1CSXLB	36000	Multi	Cassette/Duct Only	
BOSBMS500-AAS048-1CSXLB	48000	Multi	Cassette/Duct Only	
BOSBMS500-AAS060-1CSXLB	60000	Multi	Cassette/Duct Only	

Wall Mounts

Item ID	CAPACITY (BTUS)	VOLTAGE	Price
BOSBMS500-AAU009-1AHWXB	9000	230V	
BOSBMS500-AAU012-1AHWXB	12000	230V	
BOSBMS500-AAU018-1AHWXB	18000	230V	
BOSBMS500-AAU024-1AHWXB	24000	230V	
BOSBMS500-AAS030-1AHWXB	30000	230V	
BOSBMS500-AAS036-1AHWXB	36000	230V	



Ducted

Item ID	CAPACITY (BTUS)	VOLTAGE	Price
BOSBMS500-AAU009-1AHDXB	9000	230V	
BOSBMS500-AAU012-1AHDXB	12000	230V	
BOSBMS500-AAU018-1AHDXB	18000	230V	
BOSBMS500-AAU024-1AHDXB	24000	230V	
BOSBMS500-AAU036-1AHDXB	36000	230V	
BOSBMS500-AAU048-1AHDXB	48000	230V	
BOSBMS500-AAU060-1AHDXB	60000	230V	



Cassette

Item ID	CAPACITY (BTUS)	VOLTAGE	Price
BOSBMS500-AAU009-1AHCXB	9000	230V	
BOSBMS500-AAU012-1AHCXB	12000	230V	
BOSBMS500-AAU018-1AHCXB	18000	230V	
BOSBMS500-AAU024-1AHCXB	24000	230V	
BOSBMS500-AAU036-1AHCXB	36000	230V	
BOSBMS500-AAU048-1AHCXB	48000	230V	
BOS8733953125	9, 12, 18K	Grill	
BOS8733953126	24, 36, 48K	Grill	



115V Single Zone System

Item ID	CAPACITY (BTUS)	APPLICATION	MOUNT	Price
GRLIVV09HP115V1BO	9000	Single Outdoor		
GRLIVV12HP115V1AO	12000	Single Outdoor		
GRLIVV09HP115V1BH	9000	Single Indoor	Wall Mount	
GRLIVV12HP115V1AH	12000	Single Indoor	Wall Mount	



230V Single Zone Condenser

Item ID	CAPACITY (BTUS)	APPLICATION	Price
GRLIVV09HP230V1AO	9000	Single Outdoor	
GRLIVV12HP230V1AO	12000	Single Outdoor	
GRLIVV18HP230V1AO	18000	Single Outdoor	
GRLIVV24HP230V1AO	24000	Single Outdoor	
GRLIVV30HP230V1AO	30000	Single Outdoor	
GRLIVV36HP230V1AO	36000	Single Outdoor	



230V Multi Zone Condenser

Item ID	CAPACITY (BTUS)	APPLICATION	# OF ZONES	Price
GRMULTI18HP230V1CO	18000	Multi Outdoor	1-2	
GRMULTI24HP230V1CO	24000	Multi Outdoor	1-3	
GRMULTI30HP230V1CO	30000	Multi Outdoor	1-4	
GRMULTI36HP230V1CO	36000	Multi Outdoor	1-5	
GRMULTI42HP230V1CO	42000	Multi Outdoor	1-5	



230V Single/Multi Zone Indoor

Item ID	CAPACITY (BTUS)	APPLICATION	MOUNT	Price
GRLIVV09HP230V1AH	9000	Single/Multi	Wall Mount	
GRLIVV12HP230V1AH	12000	Single/Multi	Wall Mount	
GRLIVV18HP230V1AH	18000	Single/Multi	Wall Mount	
GRLIVV24HP230V1AH	24000	Single/Multi	Wall Mount	
GRLIVV30HP230V1AH	30000	Single/Multi	Wall Mount	
GRLIVV36HP230V1AH	36000	Single/Multi	Wall Mount	



Thermostats

Item ID	WIRE/WIRELESS	MATCH W/	DESCRIPTION	Price
BOSBCC100	Wired	All	Wi-Fi Thermostat	
BOS8733953129	Wired		24V Interface	
BOS8733956179	Wired	"C" Wall Mounts	Thermostat	
BOS8733953127	Wired	"A/B" Wall mounts	Thermostat	
BOS8733956180	Wired	Cassette/Ducted	Thermostat	



Wire

Item ID	CONDUCTOR	STRANDING	SHIELDING	Price
BO14-4-MS	14-4	Stranded	Unshielded	
BO14-4-MS-METAL	14-4	Stranded	Unshielded	

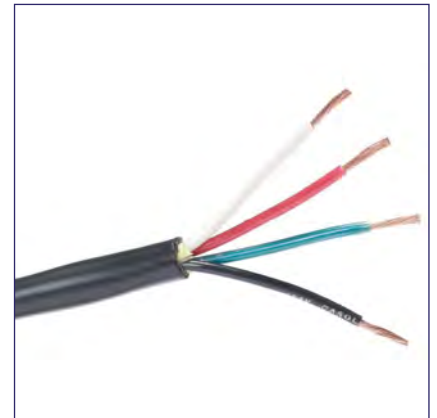

MiniSplit Bracket

Item ID	MAX DEPTH	MAX WIDTH	LOAD (LBS)	Price
REC87735	10-3/8 to 19-1/2	3 to 31	500	



MiniSplit Pad

Item ID	SIZE	MATERIAL	Price
DTEL1838-3	18 x 38 x 3	Plastic	
BR183633	18 x 36 x 3	Plastic	



Linesets

Item ID	SIZE (IN)	LENGTH (FT)	INSULATION	Price
LNS25-1438F-12-K	1/4"	25'	1/2" K-Flex	
LNS50-1438F-12-K	1/4"	50'	1/2" K-Flex	
LNS25-1412F-12-K	3/8"	25'	1/2" K-Flex	
LNS50-1412F-12-K	3/8"	50'	1/2" K-Flex	
LNS25-3858F-12-K	1/2"	25'	1/2" K-Flex	
LNS50-3858F-12-K	1/2"	50'	1/2" K-Flex	



Condensate Pump

Item ID	VOLTAGE	HOSE INCLUDED	Price
DTCVMINI	120	No	
REC83930	100-250V	No	



Lineset Cover

Item ID	TYPE	COLOR	WIDTH	Price
ACGCGKIT	Universal Kit	White	4-1/2	
ACGCGDUC	48 in	White	4-1/2	
ACGCGDUC78	78 in	White	4-1/2	
ACGCGCUP	Coupler	White	4-1/2	
ACGCGINLT	Wall Inlet	White	4-1/2	
ACGCG90	90 Elbow	White	4-1/2	
ACG3CGSTI	Soffit Inlet	White	4-1/2	
ACGCGEND	Endcap	White	4-1/2	
ACGCGEXT90	Exterior 90	White	4-1/2	
ACGCGCLP	Clips	White	4-1/2	

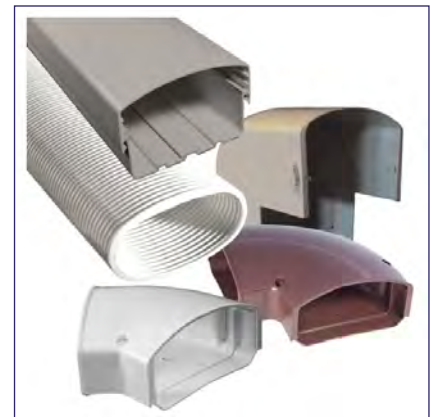

Item ID	TYPE	BTU'S	BURNER	Price
TPVHF-ABP	Low High Boy	70-106K	AFG Included	
TPVLF-DBP	Low Boy Front Flue	70-106K	AFG Included	
TPVLR-DBP	Low Boy Rear Flue	70-106K	AFG Included	



Counterflow Options

Item ID	TYPE	BTU'S	BURNER	Price
TPVC-CBP	Counterflow	69-113K	AFG Included	
TPOD6FA072D48	Counter/Horizontal	70-106K	AFG Included	



Low Profile Unit Heater with Propeller

Item ID	BTUS	VOLTAGE	Price
MODHD30AS0111	30,000	115	
MODHD45AS0111	45,000	115	
MODHD60AS0111	60,000	115	
MODHD75AS0111	75,000	115	
MODHD100AS0111	100,000	115	
MODHD125AS0111	125,000	115	



Standard Unit Heater with Propeller

Item ID	BTUS	VOLTAGE	Price
MODPDP150AE0130	150,000	115	
MODPDP175AE0130	175,000	115	
MODPDP200AE0130	200,000	115	
MODPDP250AE0130	250,000	115	
MODPDP300AE0130	300,000	115	
MODPDP350AE0130	350,000	115	
MODPDP400AE0130	400,000	115	



Burner Boxes

NG burners include LP conversion kit. 10 Year warranty

Item ID	MODEL	BTUS	Price
ENCF102650XL	ERXL	60,000	
ENCF102652XL	ERXL	80,000	
ENCF102654XL	ERXL	100,000	
ENCF102656XL	ERXL	125,000	
ENCF102658XL	ERXL	150,000	



Burner Tube Sets

Tubes, reflectors, hangers, couplers, & vent adapter, plus turbulator where necessary

Item ID	LENGTH	MATCH WITH	Price
ENCF106404XL	20	ERXL 60,80	
ENCF106405XL	30	ERXL 80	
ENCF106401XL	30	ERXL 100	
ENCF106406XL	40	ERXL 100,125	
ENCF106407XL	50	ERXL 125,150,175	
ENCF106403XL	60	ERXL 150,175	



Accessories

Item ID	TYPE	MATCH WITH	Price
ENCF125444	Thermostat	All	
ENCF106414	U-Tube Kit	All	
ENCF106415	90 Bend Kit	All	

Install Kits

Installation kits include vent cap, thermostat, shut-off valve, SS flex connector & chain kits.

Item ID	TYPE	MATCH WITH	Price
ENCF111751	Install Kit	20'	
ENCF111752	Install Kit	30'	
ENCF111753	Install Kit	40'	
ENCF111754	Install Kit	50'	
ENCF111755	Install Kit	60'	

Linesets

Item ID	LENGTH	SIZE	INSULATION	Price
LNS25-3834S-38	25	3/8 - 3/4	3/8	
LNS25-3878S-38	25	3/8 - 7/8	3/8	
LNS25-38118S-38	25	3/8 - 1-1/8	3/8	
LNS30-3858S-38	30	3/8 - 5/8	3/8	
LNS30-3834S-38	30	3/8 - 3/4	3/8	
LNS30-3878S-38	30	3/8 - 7/8	3/8	
LNS40-3834S-38	40	3/8 - 3/4	3/8	
LNS40-3878S-38	40	3/8 - 7/8	3/8	
LNS50-3858S-38	50	3/8 - 5/8	3/8	
LNS50-3834S-38	50	3/8 - 3/4	3/8	
LNS50-3878S-38	50	3/8 - 7/8	3/8	
LNS50-38118S-38	50	3/8 - 1-1/8	3/8	



Linesets "No Rip"

Item ID	LENGTH	SIZE	INSULATION	Price
LNS25-3834S-12-K	25	3/8 - 3/4	1/2 Keflex	
LNS35-3834S-12-K	35	3/8 - 3/4	1/2 Keflex	
LNS50-3834S-12-K	50	3/8 - 3/4	1/2 Keflex	
LNS25-3878S-12-K	25	3/8 - 7/8	1/2 Keflex	
LNS35-3878S-12-K	35	3/8 - 7/8	1/2 Keflex	
LNS50-3878S-12-K	50	3/8 - 7/8	1/2 Keflex	
LNS25-3834S-34-K	25	3/8 - 3/4	3/4 Keflex	
LNS35-3834S-34-K	35	3/8 - 3/4	3/4 Keflex	
LNS50-3834S-34-K	50	3/8 - 3/4	3/4 Keflex	
LNS25-3878S-34-K	25	3/8 - 7/8	3/4 Keflex	
LNS35-3878S-34-K	35	3/8 - 7/8	3/4 Keflex	
LNS50-3878S-34-K	50	3/8 - 7/8	3/4 Keflex	



Lineset Cover

Item ID	TYPE	COLOR	WIDTH	Price
ACGCGKIT	Universal Kit	White	4-1/2	
ACGCGDUC	48 in	White	4-1/2	
ACGCGDUC78	78 in	White	4-1/2	
ACGCGCUP	Coupler	White	4-1/2	
ACGCGINLT	Wall Inlet	White	4-1/2	
ACGCG90	90 Elbow	White	4-1/2	
ACG3CGSTI	Soffit Inlet	White	4-1/2	
ACGCGEND	Endcap	White	4-1/2	
ACGCGEXT90	Exterior 90	White	4-1/2	
ACGCGCLP	Clips	White	4-1/2	

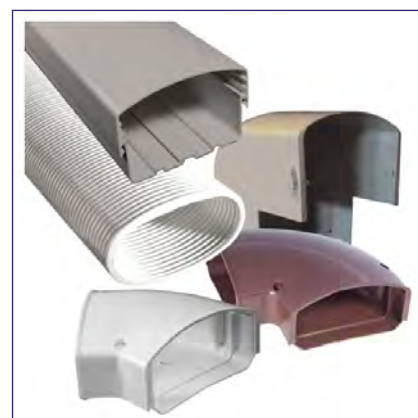

Line Set Flush

Item ID	DESCRIPTION	SIZE	Price
DTPF-08	Pro Flush Solvent	8oz	
DTPF-16	Pro Flush Solvent	16oz	
DTPF-KIT	Flush Kit	16oz	
COLS1-CSSF-05	Flush Kit	5#	
REC82400	Turbo-kleen Flush Kit	16oz	
NUC4300-30	RX-11 Refill Kit	19.5oz	
NUC4300-38	RX-11 Starter Kit	19.5oz	



Driers

Item ID	DESCRIPTION	SIZE	CAPACITY	Price
PK083S	Liquid Line Drier	3/8	083S	
PKBF083S	Biflow Drier	3/8	083S	
PK163S	Liquid Line Drier	3/8	163S	
PKBF163S	Biflow Drier	3/8	163S	



Condensate Pumps

Item ID	DESCRIPTION	VOLTAGE	OPTION	Price
DTCP-16	Condensate Pump	120v	No Tubing	
DTCP-22	Condensate Pump	120v	No Tubing	
DTCP-22T	Condensate Pump	120v	comes with 3/8" tubing	
DTCP-22LP	Condensate Pump	120v	Low Profile	
DTCP-22-230	Condensate Pump	230v		
DTCVMINI	Condensate Pump	120v	for Mini Splits	
LGVCMA-15UL	Condensate Pump	120v	No Tubing	



Condensate Control

Item ID	BRAND	DESCRIPTION	FOR	Price
NUC61041	Nu Calgon	Drain Pan Treatment	10 Tons for 6 months	
NUC61044	Nu Calgon	Drain Pan Treatment	Mini Splits	
NUC4185-20	Nu Calgon	Drain Pan Treatment	20 Ton Tab	
DTFLOW-PLUS-10	Diversitech	Drain Pan Treatment		
DTFLOW-PLUS-200	Diversitech	Drain Pan Treatment		
DTPROTREAT-151	Diversitech	Drain Pan Treatment		
DTPROTREAT-152	Diversitech	Drain Pan Treatment		
REC83114	Rectorseal	Clear Trap		
SUPJV1	Jones Valve	Cleanout Valve		

Float Switches

Item ID	BRAND	DESCRIPTION	STYLE	Price
DTWS-1	Diversitech	Wet Switch	Electronic	
DTSOS-1	Diversitech	Overflow Switch	Electronic	
REC97695	Rectorseal	Overflow Switch	Electronic	
FICFS-1	Field Controls	Overflow Switch	Float	



Honeywell Thermostat Programmable

Item ID	DESCRIPTION	TYPE	STAGES	Price
MHTH4110U2005	Thermostat	Wired	1H/1C	
MHTH6210U2001	Thermostat	Wired	2h/1C	
MHTH6320U2008	Thermostat	Wired	3H/2C	
MHTH6220WF2006	Thermostat	Wi-Fi	2H/2C	
MHTH6320WF2003	Thermostat	Wi-Fi	3H/2C	
MHTH8110R1008	Thermostat	Redlink Wireless	1H/1C	
MHTH8320R1003	Thermostat	Redlink Wireless	3H/2C	
MHTH8321R1001	Thermostat	Redlink Wireless	3H/2C	
MHTH8321WF1001	Thermostat	Wi-Fi	3H/2C	
MHTHX321WFS2001W	Thermostat	Wi-Fi	3H/2C	
MHYTHX9421R5085WW	Thermostat	Redlink Wireless	4H/2C	

Honeywell Thermostat Non Programmable

Item ID	DESCRIPTION	TYPE	STAGES	Price
MHTH1110D2009	Thermostat	Wired	1H/1C	
MHTH1110E1000	Thermostat	Wired	1H/1C	
MHT822K1000	Thermostat	Wired	Heat Only	

Honeywell Thermostat Accessories

Item ID	DESCRIPTION	TYPE	Price
MHTHM5421R1021	Equipment Interface	Redlink Wireless	
MHTHM6000R7001	Internet Gateway	Redlink Wireless	
MHC7089R1013	Outdoor Sensor	Redlink Wireless	
MHC7189R1004	Indoor Sensor	Redlink Wireless	
MHC7089U1006	Outdoor Sensor	Wired	
MHC7189U1005	Indoor Sensor	Wired	

Pro 1 Thermostat Programmable

Item ID	DESCRIPTION	TYPE	STAGES	Price
PROT705	Thermostat	Wired	1H/1C	
PROT715	Thermostat	Wired	2H/2C	
PROT805	Thermostat	Wired	1H/1C	
PROT855	Thermostat	Wired	2H/2C	
PROT855iSH	Thermostat	Wi-Fi	5H/3C	



Pro 1 Thermostat Non Programmable

Item ID	DESCRIPTION	TYPE	STAGES	Price
PROT701	Thermostat	Wired	1H/1C	
PROT721	Thermostat	Wired	2h/1C	
PROT701i	Thermostat	Wi-Fi	1H/1C	

Pro 1 Thermostat Accessories

Item ID	DESCRIPTION	TYPE	Price
PROR250S	Outdoor Sensor	Wired	
PROR251S	Indoor Sensor	Wired	
PRORZ250W	Outdoor Sensor	Wireless	
PRORZ251W	Indoor Sensor	Wireless	

Thermostat Wire

Item ID	DESCRIPTION	GAUGE	WIRES	Price
BO18-2	Thermostat Wire	18	2	
BO18-3	Thermostat Wire	18	3	
BO18-4	Thermostat Wire	18	4	
BO18-5	Thermostat Wire	18	5	
BO18-6	Thermostat Wire	18	6	
BO18-8	Thermostat Wire	18	8	
BO18-10	Thermostat Wire	18	10	



Brackets and Feet

Item ID	DESCRIPTION	SIZE (IN)	Price
MAR93631	AC Brackets	36	
MAR93632	AC Brackets	42	
MAR93636	AC Brackets	48	
BR19880	AC Brackets	36	
BR19881	AC Brackets	42	
BR19882	AC Brackets	48	
MAR79095	Leveler Furnace Feet		
BR4007	Pump Ups	6-7-1/4	
DTFB-1	Furnace Corners	2	
BRICKS	Brick		
TH17525	Twist Blocks	1-3/4 to 2-1/4	



Vibration Pad

Item ID	DESCRIPTION	SIZE (IN)	OTHER	Price
BR6132	Vibration Pad	2 x 2	Cork	
BR6133	Vibration Pad	3 x 3	Cork	
BR6134	Vibration Pad	4 x 4	Cork	
BR6136	Vibration Pad	6 X 6	Cork	
BR6138	Vibration Pad	18 X 18	Cork	
BR6733	Vibration Pad	3 X 3	Foam	
BR19709	Vibration Pad	18 x 18	All Rubber	

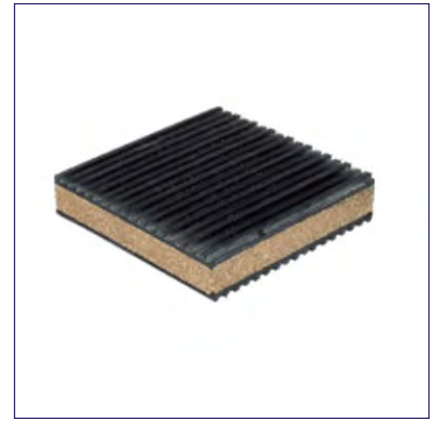

Humidifiers

Item ID	DESCRIPTION	GAL/DAY	WIRES	Price
AP500M	Manual	12		
AP600M	Manual	17		
AP700M	Manual	18		
AP400	Automatic	17		
AP500	Automatic	12		
AP600	Automatic	18		
AP700	Automatic	18		
AP800	Steam	11.5 to 34.6		



Dehumidifiers

Item ID	CAPACITY	WIRES	Price
APE080	80ppd		
APE100C	100ppd		



Media Air Cleaners

Item ID	BRAND	SIZE	WIRES	Price
AP1210	Aprilaire	20X25		
AP1410	Aprilaire	16X25		
AP2210	Aprilaire	20X25		
AP2410	Aprilaire	16X25		
TR455602-125	Trion	16X25	8	
TR455602-025	Trion	20X25	8	
TR447380-010	Trion	20X25 Angle	8	



Electronic Air Cleaner

Item ID	BRAND	SIZE	MERV RATING	Price
TR455600-125	Trion	16x25	8	
TR455600-025	Trion	20x25	8	



UV Lights

Item ID	# OF LAMPS	Price
GF4925	1	
GF4919	2	



Plasma Generator

Item ID	VOLTAGE	Price
PHED-1.2-1-115V-CPG	115V	
PHED-1.2-2-208V-CPG	208V	



Plenum

Knocked down plenum open, comes with a cap, and 1/2" hem flange

Item ID	DIMENSIONS	Price
SWPL-132035-HC	13-1/2 X 20 X 35	
SWPL-132047-HC	13-1/2 X 20 X 47	
SWPL-162035-HC	16-1/2 X 20 X 35	
SWPL-162047-HC	16-1/2 X 20 X 47	
SWPL-202035-HC	20 X 20 X 35	
SWPL-202047-HC	20 X 20 X 47	
SWPL-232035-HC	23-1/2 X 20 X 35	
SWPL-232047-HC	23-1/2 X 20 X 47	

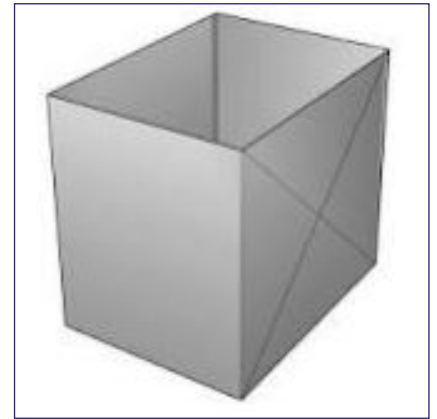

Return Air Box

Return Air Box with open top to set equipment on. Made of 24 gauge metal.

Item ID	DIMENSIONS	Price
SWRAB-14-1/2-HC	14-1/2 X 28-3/8 X 21	
SWRAB-17-1/2-HC	17-1/2 X 28-3/8 X 21	
SWRAB-21-HC	21 X 28-3/8 X 21	
SWRAB-24-1/2-HC	24-1/2 X 28-3/8 X 21	
SWRAB-AH18-1/2-HC	18-1/2 X 22 X 21	
SWRAB-AH21-1/2-HC	21-1/2 X 22 X 21	
SWRAB-AH24-1/2-HC	24-1/2 X 22 X 21	
SWRAB-AH20 BOSCH	19-5/8 X 21-5/8 X 21	
SWRAB-AH22 BOSCH	22 X 24 X 21	



Panning/Drives/Angle

Single and Double Panning made of 28 gauge.

Item ID	DIMENSIONS	TYPE	Price
SW48173528	17 X 35	Panning	
SW48323528	32 X 35	Panning	
SW6S60	60	S Cleat	
SW8D60	60	Drive	
SHE SS5	60	S Cleat	
SHE DC5	60	Drive	
SW1 X 1 26 GA ANGLE	1 x 60	Angle	
SW1 X 2 26 GA ANGLE	2 x 60	Angle	
SW1 X 3 26 GA ANGLE	3 x 60	Angle	
SW1 X 4 26 GA ANGLE	4 x 60	Angle	

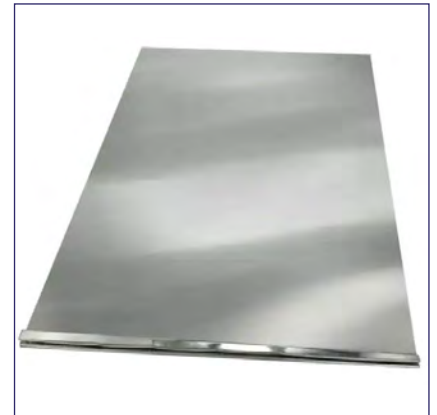

Sheet Metal Screws

Item ID	TYPE	QUANTITY	SIZE	Price
MCHW8X1/2ZG	Zip In	100	8 X 1/2	
MCHW8X1/2ZT	Zip In	1000	8 X 1/2	
MCHW8X1/2Z	Zip In	12000	8 X 1/2	
MCHW8X3/4ZT	Zip In	1000	8 X 3/4	
MCHW8X1ZX	Zip In	100	8 X 1	
MCHW8X1ZT	Zip In	500	8 X 1	
MCHW8X1Z	Zip In	7000	8 X 1	
MCHW8X11/2ZT	Zip In	250	8 X 1-1/2	
MCHW8X2ZT	Zip In	250	8 X 2	
MCHW7X1/2ZT	Zip In	1000	7 X 1/2	
MCHW10X1ZT	Zip In	500	10 X 1	
MCBT131X	Bit Tip	100	8-18 X 1/2	
MCBT131T	Bit Tip	1000	8-18 X 1/2	
MCBT133T	Bit Tip	500	8-18 X 3/4	
MCBT143X	Bit Tip	100	10-16 X 3/4	
MCBT143T	Bit Tip	500	10-16 X 3/4	



Wire Nuts (GBN Alternative Available)

Item ID	DESCRIPTION	COLOR	SIZE	Price
MAR25880	Wire Nut	Gray		
MAR25881	Wire Nut	Blue		
MAR25882	Wire Nut	Orange		
MAR25883	Wire Nut	Yellow		
MAR25884	Wire Nut	Red		



Wire Ties (GBN Alternative Available)

Item ID	DESCRIPTION	LENGTH	COLOR	Price
MAR86104	Wire Tie	6	Natural	
MAR86105	Wire Tie	6	Black	
MAR86106	Wire Tie	8	Natural	
MAR86107	Wire Tie	8	Black	
MAR86108	Wire Tie	11	Natural	
MAR86109	Wire Tie	11	Black	
HIL1891190	Tension Tool			



Silicone Sealant

Item ID	COLOR	MATERIAL	SIZE	Price
BS37000	Clear	Silicone	10.1oz	
BS37001	White	Silicone	10.1oz	
BS37002	Black	Silicone	10.1oz	
BS37003	Aluminum	Silicone	10.1oz	
BS37610	Red	Hi Temp	10.1oz	



Tape (3M provided in Morrow Market)

Item ID	DESCRIPTION	SIZE	COLOR	Price
DT640-AF2	Aluminum	2" x 150'	Silver	
DT640-AF25	Aluminum	2-1/2" x 150'	Silver	
DT640-AF3	Aluminum	3" x 150'	Silver	
DT640-UL25	Aluminum	2-1/2 x 180'	Silver w/ Lettering	
DT640-FD2S	Silver	2" x 360'	Silver	
DTPC-622-S	Duct	2" x 180'	Silver	
DTPC-609-B	Duct	2" x 180'	Black	
INSHFAB012	Insulation	3" x 150'	White	
DT6-3460	Electrical	3/4" x 150'	Black	
DTET33	3M Electrical	3/4 x 66'	Black	
MLMA-FT1	Foam	2" x 30'	Black	
MAR93505	Cork	2" x 30'	Cork	
MI70885	Teflon	1/2" 1429"	Blue	
MI70886	Teflon	3/4" x 1429"	Blue	



Refrigerant Caps

Item ID	DESCRIPTION	COLOR	QUANTITY	Price
REC86661	Refrigerant Cap	Green	10pk	
REC86681	Refrigerant Cap	Pink	10pk	
REC86691	Refrigerant Cap	Silver	10pk	
REC86683	Refrigerant Cap	Pink	each	
REC86693	Refrigerant Cap	Silver	each	
REC86660	Screwdriver	Green/Silver		
REC86688	Screwdriver	Pink		
REC86698	Multi-Key	Fits Most		



Hard Starts

Item ID	DESCRIPTION	FOR	MISC.	Price
FTOCSRU1	Hard Start	1-3 Tons	Separate Relay	
FTOCSRU2	Hard Start	3.5-5 Tons	Separate Relay	
PACTQS5	Hard Start	1.5 Ton	All in one	
PACTQS6	Hard Start	1.5-3 Tons	All in one	
PACTQS8	Hard Start	3.5 to 5 Tons	All in one	



ACR Press Fittings Tools

Item ID	DESCRIPTION	Price
CUP ACR TOOL 24KN	Crimp Tool	
CUP ACR TOOL 32KN	Crimp Tool	
CUP ACR JAW KIT 24KN	Jaw Kit	
CUP ACR JAW KIT 32KN	Jaw Kit	
CUP ACR 32KN JAW W/ DEPTH GAUGE	Depth Gauge	
CUP ACR INSTALL KIT MZK-IK	Install Kit	

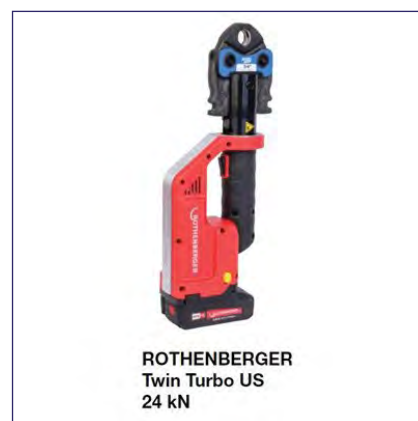

ACR Press Fittings Zoomlock Max

Item ID	TYPE	SIZE	Price
CUP ACR E 1/2 A PRS X PRS	45 Elbow	1/2	
CUP ACR E 1/4 A PRS X PRS	45 Elbow	1/4	
CUP ACR E 1-1/8 A PRS X PRS	45 Elbow	1-1/8	
CUP ACR E 1-3/8 A PRS X PRS	45 Elbow	1-3/8	
CUP ACR E 3/4 A PRS X PRS	45 Elbow	3/4	
CUP ACR E 3/8 A PRS X PRS	45 Elbow	3/8	
CUP ACR E 5/8 A PRS X PRS	45 Elbow	5/8	
CUP ACR E 7/8 A PRS X PRS	45 Elbow	7/8	
CUP ACR E 1/2 PRS X PRS	90 Elbow	1/2	
CUP ACR E 1/4 PRS X PRS	90 Elbow	1/4	
CUP ACR E 1-1/8 X 1-1/8 PRS X PRS	90 Elbow	1-1/8	
CUP ACR E 1-3/8 X 1-3/8 PRS X PRS	90 Elbow	1-3/8	
CUP ACR E 3/4 PRS X PRS	90 Elbow	3/4	
CUP ACR E 3/8 PRS X PRS	90 Elbow	3/8	
CUP ACR E 5/8 PRS X PRS	90 Elbow	5/8	
CUP ACR E 7/8 PRS X PRS	90 Elbow	7/8	
CUP ACR E LR 1/2 PRS X PRS	90 LR Elbow	1/2	
CUP ACR E LR 1-1/8 PRS X PRS	90 LR Elbow	1-1/8	
CUP ACR E LR 1-3/8 PRS X PRS	90 LR Elbow	1-3/8	
CUP ACR E LR 3/4 PRS X PRS	90 LR Elbow	3/4	
CUP ACR E LR 5/8 PRS X PRS	90 LR Elbow	5/8	
CUP ACR E LR 7/8 PRS X PRS	90 LR Elbow	7/8	
CUP ACR STRE 1/2 PRS X PRS	90 Str Elbow	1/2	
CUP ACR STRE 1-1/8 PRS X PRS	90 Str Elbow	1-1/8	
CUP ACR STRE 1-3/8 PRS X PRS	90 Str Elbow	1-3/8	
CUP ACR STRE 3/4 PRS X PRS	90 Str Elbow	3/4	
CUP ACR STRE 3/8 PRS X PRS	90 Str Elbow	3/8	



SUPPLIES

Item ID	TYPE	SIZE	Price
CUP ACR STRE 5/8 PRS X PRS	90 Str Elbow	5/8	
CUP ACR STRE 7/8 PRS X PRS	90 Str Elbow	7/8	
CUP ACR C 1/2 PRS X PRS	Cap	1/2	
CUP ACR C 1/4 PRS X PRS	Cap	1/4	
CUP ACR C 1-1/8 PRS X PRS	Cap	1-1/8	
CUP ACR C 1-3/8 PRS X PRS	Cap	1-3/8	
CUP ACR C 3/4 PRS X PRS	Cap	3/4	
CUP ACR C 3/8 PRS X PRS	Cap	3/8	
CUP ACR C 5/8 PRS X PRS	Cap	5/8	
CUP ACR C 7/8 PRS X PRS	Cap	7/8	
CUP ACR CPL 1/2 PRS X PRS	Coupling	1/2	
CUP ACR CPL 1/4 PRS X PRS	Coupling	1/4	
CUP ACR CPL 1-1/8 PRS X PRS	Coupling	1-1/8	
CUP ACR CPL 1-3/8 PRS X PRS	Coupling	1-3/8	
CUP ACR CPL 3/4 PRS X PRS	Coupling	3/4	
CUP ACR CPL 3/8 PRS X PRS	Coupling	3/8	
CUP ACR CPL 5/8 PRS X PRS	Coupling	5/8	
CUP ACR CPL 7/8 PRS X PRS	Coupling	7/8	
CUP ACR P-TRAP 1/2 X 1/2 PRS X PRS	P Trap	1/2	
CUP ACR P-TRAP 1-1/8 X 1-1/8 PRS X PRS	P Trap	1-1/8	
CUP ACR P-TRAP 1-3/8 X 1-3/8 PRS X PRS	P Trap	1-3/8	
CUP ACR P-TRAP 7/8 PRS X PRS	P Trap	7/8	
CUP ACR TRAP 3/4 PRS X PRS	P Trap	3/4	
CUP ACR TRAP 5/8 PRS X PRS	P Trap	5/8	
CUP ACR RC 1/2 X 1/4 PRS X PRS	Reducer	1/4 - 1/2	
CUP ACR RC 1/2 X 3/8 PRS X PRS	Reducer	3/8 - 1/2	
CUP ACR RC 1-1/8 X 3/4 PRS X PRS	Reducer	3/4 - 1-1/8	
CUP ACR RC 1-1/8 X 5/8 PRS X PRS	Reducer	5/8 - 1-1/8	
CUP ACR RC 1-1/8 X 7/8 PRS X PRS	Reducer	7/8 - 1-1/8	
CUP ACR RC 1-3/8 X 1-1/8 PRS X PRS	Reducer	1-3/8 - 1-1/8	
CUP ACR RC 1-3/8 X 7/8 PRS X PRS	Reducer	1-3/8 - 7/8	
CUP ACR RC 3/4 X 1/2 PRS X PRS	Reducer	1/2 - 3/4	
CUP ACR RC 3/8 X 1/4 PRS X PRS	Reducer	1/4 - 3/8	
CUP ACR RC 5/8 X 1/2 PRS X PRS	Reducer	1/2 - 5/8	
CUP ACR RC 5/8 X 1/4 PRS X PRS	Reducer	1/4 - 5/8	
CUP ACR RC 5/8 X 3/4 PRS X PRS	Reducer	5/8 - 3/4	
CUP ACR RC 5/8 X 3/8 PRS X PRS	Reducer	3/8 - 5/8	
CUP ACR RC 5/8 X 7/8 PRS X PRS	Reducer	5/8 - 7/8	
CUP ACR RC 7/8 X 1/2 PRS X PRS	Reducer	1/2 - 7/8	
CUP ACR RC 7/8 X 3/4 PRS X PRS	Reducer	3/4 - 7/8	
CUP ACR AD 1/2 PRS X FL	SAE Flare	1/2	
CUP ACR AD 1/4 PRS X FL	SAE Flare	1/4	
CUP ACR AD 3/8 PRS X FL	SAE Flare	3/8	
CUP ACR AD 5/8 PRS X FL	SAE Flare	5/8	
CUP ACR CPL SLP 1/2 X 1/2 PRS X PRS	Slip Coupling	1/2	
CUP ACR CPL SLP 1/4 X 1/4 PRS X PRS	Slip Coupling	1/4	
CUP ACR CPL SLP 1-1/8 X 1-1/8 PRS X PRS	Slip Coupling	1-1/8	
CUP ACR CPL SLP 3/4 X 3/4 PRS X PRS	Slip Coupling	3/4	
CUP ACR CPL SLP 3/8 X 3/8 PRS X PRS	Slip Coupling	3/8	
CUP ACR CPL SLP 5/8 X 5/8 PRS X PRS	Slip Coupling	5/8	
CUP ACR CPL SLP 7/8 X 7/8 PRS X PRS	Slip Coupling	7/8	
CUP ACR T 1/2 PRS X PRS	Tee	1/2	
CUP ACR T 1/4 PRS X PRS	Tee	1/4	
CUP ACR T 1-1/8 PRS X PRS	Tee	1-1/8	
CUP ACR T 1-3/8 PRS X PRS	Tee	1-3/8	
CUP ACR T 3/4 PRS X PRS	Tee	3/4	
CUP ACR T 3/8 PRS X PRS	Tee	3/8	



Item ID	TYPE	SIZE	Price
CUP ACR T 5/8 PRS X PRS	Tee	5/8	
CUP ACR T 7/8 PRS X PRS	Tee	7/8	
CUP ACR 7 1-1/8 PRS X PRS	Wye	1-1/8	
CUP ACR Y 1/2 PRS X PRS	Wye	1/2	
CUP ACR Y 3/4 PRS X PRS	Wye	3/4	
CUP ACR Y 3/8 PRS X PRS	Wye	3/8	
CUP ACR Y 5/8 PRS X PRS	Wye	5/8	
CUP ACR Y 7/8 PRS X PRS	Wye	7/8	



Akron (Morrow Control)

1055 Grant St
Akron, OH 44311
Phone: 330-773-6141

Canton (Morrow Control)

810 Marion Motley Ave. NE
Canton, OH 44705
Phone 330-452-9791

Cincinnati (Winstel Controls)

2822 Spring Grove Avenue
Cincinnati, OH 45225
Phone: 513-541-2142

Cleveland (Morrow Control)

3905 West 150th St
Cleveland, OH 44111
Phone: 216-252-3055

Hamilton (Winstel Controls)

208 North B St
Hamilton, OH 45013
Phone: 513-863-8600

New Philadelphia (Morrow Control)

423 4th Street NE
New Philadelphia, OH 44663
Phone: 330-343-6669

Tri-County (Winstel Controls)

10126 Transportation Way
Cincinnati, OH 45246
Phone: 513-251-4343

Visit Us Online 24/7/365 to see your account details, pricing, availability, technical information at
www.winstelcontrols.com

Prices are subject to change. We are committed to illustrate and describe products accurately. Such descriptions and illustrations are for the purpose of identification and do not imply that the products will conform to the descriptions or illustrations.

Copyright 2023 Winstel Controls Inc.